

GRATING SIZES	
Part Number (White)	Description
PE-04-WT	Grate Perpendicular 4"
PE-06-WT	Grate Perpendicular 6"

Grating Fasteners

- Stainless steel clips and fasteners sold separately
- See installation instructions for more details

All drawing dimensions supplied by Neptune-Benson, are for reference only. All drawings were created using AutoCAD file format (*.dwg) and are presented as a service to our customers. Errors sometimes occur during this process and with software incompatibility upon opening a file. Neptune-Benson, and/or any authorized distributor of our products will not be held responsible for problems arising from files which have been converted and does not warranty the documents against deficiencies or typographical errors of any kind. We recommend that all measurements are verified with actual physical product before any custom fabrication in the field occurs.

R 06/20/19

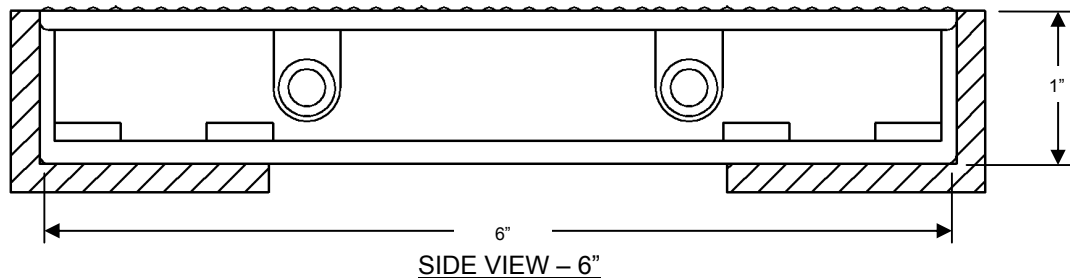
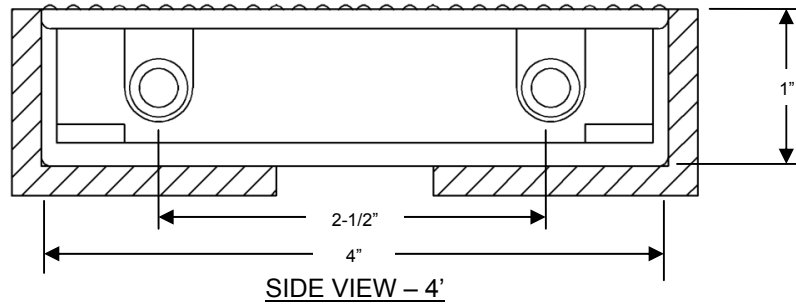
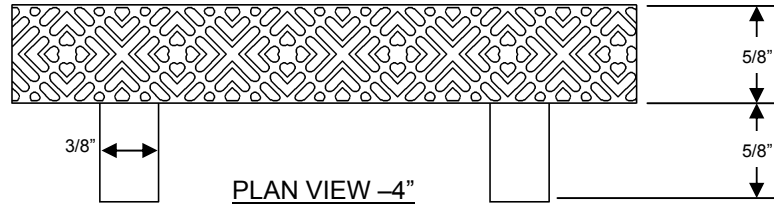

GRATING SIZES	
Part Number (White)	Description
PE-04-WT	Grate Perpendicular 4"
PE-06-WT	Grate Perpendicular 6"
CA-NOTAIL-WT	Curb Angle No Tail

Grating Fasteners

- Stainless steel clips and fasteners sold separately
- See installation instructions for more details

All drawing dimensions supplied by Neptune-Benson, are for reference only. All drawings were created using AutoCAD file format (*.dwg) and are presented as a service to our customers. Errors sometimes occur during this process and with software incompatibility upon opening a file. Neptune-Benson, and/or any authorized distributor of our products will not be held responsible for problems arising from files which have been converted and does not warrant the documents against deficiencies or typographical errors of any kind. We recommend that all measurements are verified with actual product before any custom fabrication in the field occurs.

R 06/20/19

Neptune-Benson is the leader in the design/build and delivery of cost-effective, made-to-order drainage systems that easily conform to most freeform shapes for all deck level, beach entry and rim-flow pool designs. In addition, we offer three designs of perpendicular size grating – a small “T” bar for deck drains up to 6” wide, a larger “T” bar for widths 8” to 12” and an “I” bar for drains 14” to 20” wide.

Designed to capture and disperse water surge in a matter of inches, and speed flow rate.

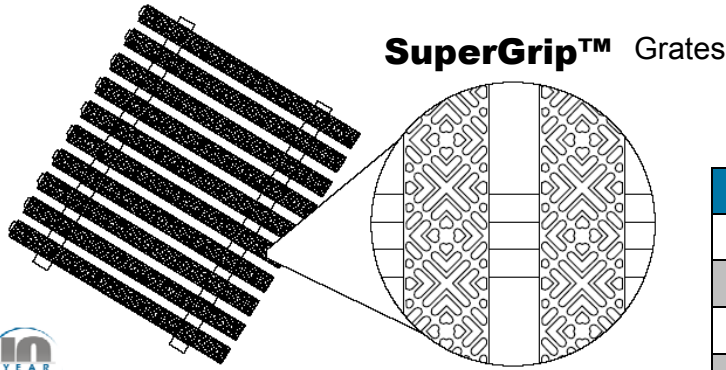

SPECIFICATIONS	
Size	4” and 6”, 8”-12” & 14”-20” widths
Material	PVC
Surface	Non-Skid surface
Grate	White, Gray and Bone
Open Area	25%
Rating	ASTM G-154 750 Hours UV ASTM C-1028 static coefficient of friction, wet and dry ANSI/APSP-16

EDGE TREATMENTS (See provided specifications for additional details)

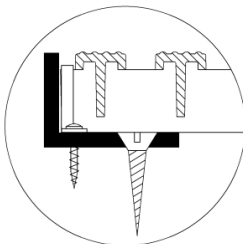

PVC CURB ANGLE

PVC Curb Angles (without tail) are designed for a sharp finished edge and allows grating to meet the deck for tile setting or deck finishing. Curb angles are mechanically fastened to pool beam and surrounding deck area.

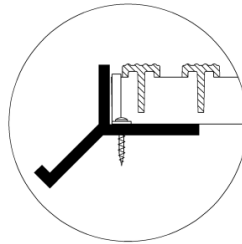

PVC CURB ANGLE WITH CONTINUOUS SECURING LEG

PVC Curb Angles (with tail) are designed with the same features as the standard curb angle, but also offers an additional PVC 45 degree leg molded for anchoring into wet concrete. This product is installed during the forming of gutter areas only.

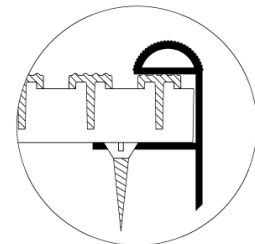

PVC HAND HOLD BRACKET

For added safety and a comfortable way for a swimmer to hold on to the edge of the pool, use our PVC Hand Hold Bracket. PVC Hand Holds are designed to be mechanically fastened to the pool beam. All Lawson Aquatics® grating can be installed in a released slot along the back of the Hand Hold..

FASTENERS & HOLD DOWN CLIPS



PVC CURB ANGLE (No Tail) & HAND HOLD

Secure to concrete at 18 inch (max) intervals with anchors and stainless steel screws supplied by installer.

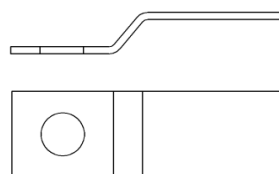

GRATE CLIPS & FASTENERS

Stainless steel clips and tamper proof fasteners supplied by Neptune-Benson installed at 2 foot intervals or as specified.